

# Archaeological Evaluation of Land (Phase 1) at Rattle Road, Stone Cross, Pevensey, East Sussex



NGR: TQ 62273 04422

Site Code: PEV/EV/15

(Planning Application: WD/2013/1564/MAO)

Date of Report: 29/10/2015

**SWAT Archaeology**

The Office, School Farm Oast

Graveney Road Faversham, Kent, ME13 8UP

Email: [info@swatarchaeology.co.uk](mailto:info@swatarchaeology.co.uk)

Tel.: 01795 532548 and 07885 700112

## Contents

List of Figures.....	3
List of Plates.....	3
1. Summary.....	4
2. Introduction.....	4
3. Site Description and Topography.....	4
4. Planning Background.....	5
5. Archaeological and Historical Background.....	5
6. Aims and Objectives.....	6
7. Methodology.....	7
8. Monitoring.....	7
9. Results.....	7
10. Discussion.....	15
11. Finds.....	15
12. Conclusion.....	15
13. Acknowledgements.....	15
14. References.....	16
16. Appendix.....	16
17. Figures.....	

List of Figures:

Figure 1 – Location of site and evaluation trench

Figure 2 – Plan of evaluation trench

Figure 3 – Trench 3

Figure 4 – Trench 4

Figure 5 – Trench 7

Figure 6 – Trench 11

Figure 7 – Sections

Figure 8 - Sections

List of Plates:

Plate 1 –Trench 1 Feature [101]

Plate 2 – Trench 3 Feature [301]

Plate 3 – Trench 4 Feature [701]

Plate 4 – Trench 7 Feature [701]

Plate 5 – Trench 11 looking north

Plate 7- Small finds

# **Archaeological Evaluation of Land (Phase 1) at Rattle Road, Stone Cross, Pevensey, East Sussex**

NGR: TQ 62273 04422

Site Code: PEV/EV/15

## **1. Summary**

*Swale & Thames Survey Company (SWAT) carried out an archaeological evaluation of land at Rattle Road, Stone Cross, Pevensey in East Sussex. A Planning Application (WD/2013/1564/MAO) to develop this site for residential use was submitted to Wealden District Council, whereby the Council requested that an Archaeological Evaluation be undertaken in order to determine the possible impact of the development on any archaeological remains. The work was carried out in accordance with the requirements set out within an Archaeological Specification (SWAT Archaeology 2015) and in discussion with the Archaeological Heritage Officer, East Sussex County Council. The results of the excavation of 45 evaluation trenches revealed a number of archaeological features present within the trenches located in the north east corner of the Proposed Development Site (PDA), with a pit and linears containing three sherds of Prehistoric pottery, seven sherds of Early to Mid Roman pottery, a single sherd of Mid Saxon pottery, five sherds from the Early Medieval period and one sherd from the Post Medieval period and one sherd from the Late Post Medieval period. Small finds retrieved include a WW1 mess tin, knife fork and spoon and a James 1<sup>st</sup> half groat (2<sup>nd</sup> coinage) dated to 1604-1619.*

*The natural geology of Wealden Clay was reached at an average depth of between 0.20m and 0.25m below the modern ground surface with archaeological features cutting into the natural geology.*

*The Archaeological Evaluation has therefore been successful in fulfilling the primary aims and objectives of the Archaeological Specification (SWAT Archaeology 2015).*

## **2. Introduction**

Swale & Thames Survey Company (SWAT) was commissioned by Persimmon (South-East) to carry out an archaeological evaluation at the above site. The work was carried out in accordance with the requirements set out within an Archaeological Specification (SWAT Archaeology) and in discussion with the Archaeological Heritage Officer, East Sussex County Council. The evaluation was carried out from July 13<sup>th</sup> to July 24<sup>th</sup> 2015. 45 evaluation trenches were dug of varying lengths due to site restraints such as standing trees, ditches, fences.

## **3. Site Description and Topography**

The proposed development site is centered on TQ 62273 04422 and forms an L-shaped group of fields bordered by housing development to the west, the B2191 Stone Cross to Westham Road with ribbon housing development to the south with Peeling Lane to the north and fields to the east. The

British Geological Survey (Sheet E319/334) identifies the underlying solid geology as Weald Clay Formation on the southern part of the site and Tunbridge Wells Sand Formation on the northern part. The geology exposed on site was the Weald Clay Formation. The site is set on sloping ground rising from c.20m AOD in the south east to c.26m AOD in the north west.

#### **4. Planning Background**

Wealden District Council gave planning permission (WD/2013/1564/MAO) for development of land at The Wells, Rattle Road, Stone Cross, Pevensey BN24 5DX for the erection of up to 276 houses, vehicular and pedestrian access, associated car parking, landscaping and open space.

On the advice of the Archaeological Heritage Officer for East Sussex County Council, a programme of archaeological works in the form of an initial archaeological evaluation was attached to the consent:

*(Condition 4) No development shall take place until the applicant has secured the implementation of a programme of archaeological works in accordance with a written scheme of investigation which has been submitted by the applicant and approved by the Local Planning Authority, including, where appropriate, retention in situ. A written record of any archaeological works undertaken shall be submitted to the Local Planning Authority within 3 months of the completion of any archaeological investigation unless an alternative timescale for submission of the report is first agreed in writing with the Local Planning Authority.*

*REASON: To enable the recording of any items of historical or archaeological interest, in accordance with Policy BE12 of the Non Statutory Wealden Local Plan, coupled with the requirements of paragraphs 129, 131 and 132 of the National Planning Policy Framework 2012.*

*NOTE: The applicant is advised that further Archaeological Works, including trial trenching will be required in order to inform the consideration of the reserved matters submission and therefore should be undertaken in good time before the submission of any reserved matters application.*

The results from this evaluation will be used to inform ESCC and Wealden District Council of any further archaeological mitigation measures that may be necessary in connection with the development proposals.

#### **5. Archaeological and Historical Background**

The archaeological record for Pevensey includes two Scheduled Monuments, the Roman fort of Pevensey to the east and Shinewater Bronze Age settlement to the south west. The PDA is within an Archaeological Notification Area. The geophysical survey (MES 2290 September 2013, Appendix 1 and Figure 2) shows the Roman road to the Saxon Shore Fort of *Anderitum* runs across the site from east to west and in addition the geophysical survey has shown field systems on a different alignment to the road. In addition another geophysical survey 250m south-east of the PDA shows significant archaeological remains as yet undated but in character Romano- British or Medieval (MES 23935). Of particular interest recent documentary research of an area about 750m east of the PDA indicates the site of the lost medieval village of 'Cudnow' (MES 5053).

The South East Research Framework (SERF) sets out a draft research agenda for improving the understanding of the Roman period in the region (Booth 2013). The biggest problem that research needs to address is how the Romano-British countryside of our region operated and the challenge is to move beyond the speculative assumptions about the relationship of villas and non villa settlements and to use all our evidence....to refine understanding of the complex interrelationships of our varied rural communities (Booth 2013:19).

Further details of previous discoveries and investigations within the immediate and wider area may be found in the East Sussex County Council Historic Environment Record and in the SWAT Archives (SWAT 2015). The ESCC records have been accessed by SWAT Archaeology. The Historical Environment Record (HER) data maintained by ESCC has been summarised in a Desk-based Archaeological Assessment commissioned by the client from Heritage Collective dated July 2013. In addition a Geophysical Survey was commissioned from Chris Butler Archaeological Services in September 2013.

## **6. Aims and Objectives**

According the Archaeological Specification, the aims and objectives for the archaeological work were to ensure that “the archaeological work should be carried out in a phased approach and will commence with evaluation through trial trenching. This initial phase should determine whether any significant archaeological remains would be affected by the development and if so what mitigation measures are appropriate’ (SWAT Archaeology 2015).

The National Planning Policy Framework (NPPF) and Heritage Assets clarifies a developers responsibilities in paragraphs 12.8 and 14.1.

Paragraph 12.8 states:

*In determining applications, local planning authorities should require an applicant to describe the significance of any heritage assets affected, including any contribution made by their setting. The level of detail should be proportionate to the assets’ importance and no more than is sufficient to understand the potential impact of the proposal on their significance. As a minimum the relevant historic environment record should have been consulted and the heritage assets assessed using appropriate expertise where necessary. Where a site on which development is proposed includes or has the potential to include heritage assets with archaeological interest, local planning authorities should require developers to submit an appropriate desk-based assessment and, where necessary, a field evaluation.*

Paragraph 14.1 states:

*Local planning authorities should make information about the significance of the historic environment gathered as part of plan-making or development management publicly accessible. They should also*

*require developers to record and advance understanding of the significance of any heritage assets to be lost (wholly or in part) in a manner proportionate to their importance and the impact, and to make this evidence (and any archive generated) publicly accessible. However, the ability to record evidence of our past should not be a factor in deciding whether such loss should be permitted.*

The aims set out in the SWAT Archaeology specification (2015) for the site required a phased approach to the mitigation of the development site commencing with an evaluation, with the results influencing the possibility of further work on the site such as further mitigation in the form of a watching brief or strip map and sample depending upon the amount and significance of any possible archaeological remains.

## **7. Methodology**

The Archaeological Specification called for an evaluation by trial trenching comprising 51 trenches within the footprint of the proposed development. Some trenches had to be re-aligned due to the restrictions of the site and to avoid impacting on standing trees which are to be preserved. Other were not able to be dug but others extended to make up the % shortfall. Despite this archaeological activity was uncovered within the trenches located in the north east area of the site.

A 7.5 ton 360° tracked mechanical excavator with a flat-bladed ditching bucket was used to remove the topsoil and subsoil to expose the natural geology and/or the archaeological horizon. All archaeological work was carried out in accordance with the specification. A single context recording system was used to record the deposits, and context recording numbers were assigned to all deposits for recording purposes. These are used in the report and shown in **bold**. All archaeological work was carried out in accordance with SWAT and IFA standards and guidance.

## **8. Monitoring**

Curatorial monitoring was available during the course of the evaluation.

## **9. Results**

The evaluation has identified the presence of archaeological remains which appear to be confined to the north east corner of the site in Trenches 1, 3, 4, 7 and 11 with a pit and linears. Three sherds of Prehistoric pottery, seven sherds of Early to Mid Roman pottery, a single sherd of Mid Saxon pottery, five sherds from the Early Medieval period and one sherd from the Post Medieval period and one sherd from the Late Post Medieval period were recovered (Appendix 00). Further archaeological investigation may prove the function and extent of the features within the north east area of the proposed development.

The evaluation has succeeded in mapping (and where appropriate, sample excavating) features that will require further investigation once the mitigation areas and excavation methodology have been agreed with ESCC. The trenches with features will be described first:

### **Trench 1**

Trench orientation: north-east to south-west. Depth: 0.30 – 0.55m. Width: 1.5m. Length: 21m.

Two linears [101] [103] and one service trench.

The plan and sections are recorded in Figures 2, 7 (see also Plate 1). The trench lay on a north-east to south-west alignment and measured 21m by 1.50m.

Undisturbed natural geology **(100)** was identified across the trench as grey sticky clay of the Wealden Clay formation, at a depth of approximately 0.15m (19.05mOD) below the present ground surface at 19.20m OD at the south-west end of the trench.

Cut into the natural geology mid centre of the trench were two linears. The linear to the west was approximately 0.98m in breadth, extending from north-west to south-east. The cut **[103]** had concave sides and a flat base. The fill **(102)** consisted of a mixture of mid brown grey clay silt with small slightly worn pottery sherds and natural flints. Pottery of a broadly Early – Mid Roman nature was recovered from the feature.

The linear to the east was about 0.74m in breadth, extending north-west to south-east. The cut **[101]** had concave sides and a flat base. The fill **(100)** consisted of a mixture of mid brown grey clay silt with small slightly worn pottery sherds and natural flints. Two pottery sherds of a broadly Early – Mid Roman nature was recovered from the feature, only slightly worn and may derive from an undisturbed contemporary deposit and dateable to about c100-150AD (Appendix 00).

Both features were sealed by a clean layer of light grey to brown subsoil **(105)** 0.22m thick.

Above this was a dark layer of topsoil **(104)** 0.10m thick, dark brown to grey in colour and containing small stones and roots, but otherwise relatively clean. This probably represents a post-medieval to modern topsoil layer filled with a high organic content from agricultural or garden use.

### **Trench 3**

Trench orientation: north to south. Depth: 0.2 – 0.4m. Width: 1.55m. Length: 21.4m

One linear [301] and one service trench.

The plan and sections are recorded in Figures 3, 7 (see also Plate 2). The trench lay on a south to north alignment and measured approximately 21.40m by 1.55m.



Undisturbed natural geology **(306)** was identified across the trench as grey sticky clay of the Wealden Clay formation, at a depth of approximately 0.23m (18.99mOD) below the present ground surface at 19.22m OD at the N end of the trench.

Cut into the natural geology mid centre of the trench was one linear **[301]**. The linear was approximately 2.21m in breadth, extending from east to west. The cut **[301]** was 'u' shaped with concave sides with a flat base. The fill **(300)** consisted of a mixture of mid brown grey clay silt with moderate speckling of manganese inclusions, fairly heavily worn pottery sherds and natural flints. Three pottery sherds of a broadly Early – Mid Roman nature was recovered from the feature (Appendix 00).

These features were sealed by a clean layer of light grey to brown subsoil **(305)** 0.17m thick.

Above this was a dark layer of topsoil **(304)** 0.15m thick, dark brown to grey in colour and containing small stones and roots, but otherwise relatively clean.

#### **Trench 4**

Trench orientation: east to west. Depth: 0.3 – 0.4m. Width: 1.5m. Length: 14.8m

One linear [401]

The plan and sections are recorded in Figures 4, 7 (see also Plate 3). The trench lay on a north-east to south-west alignment and measured approximately 14.8m by 1.50m.

Undisturbed natural geology **(407)** was identified across the trench as grey sticky clay of the Wealden Clay formation, at a depth of approximately 0.20m (19.52m OD) below the present ground surface at 19.72m OD at the east end of the trench

Cut into the natural geology at the centre of the trench was a linear approximately 1.15m in breadth and about 0.73m deep, extending from north to south. The cut **[401]** had concave sides and a rounded base. The fill **(400)** consisted of a mixture of light brown grey clay silt with moderate speckling of manganese inclusions, highly worn pottery sherds and natural flints. A single sherd of a broadly Early-Mid Roman nature was recovered from the feature.

Above this was a dark layer of topsoil **(406)** 0.12m thick, dark brown to grey in colour and containing small stones and roots, but otherwise relatively clean.

#### **Trench 7**

Trench orientation: east to west. Depth: 0.2 – 0.4m. Width: 1.5m. Length: 21.7m

One oval pit [701] and two service trenches

The plan and sections are recorded in Figures 5, 7 (see also Plate 4). The trench lay on a west to east alignment and measured approximately 21.70m by 1.50m.

Undisturbed natural geology **(702)** was identified across the trench as grey sticky clay of the Wealden Clay formation, at a depth of approximately 0.23m (19.78mOD) below the present ground surface at 20.01m OD.

Cut into the subsoil was a pit **[701]** 54cm in width and 43cm depth with a fill **(700)** consisting of a mixture of light brown grey clay silt with moderate speckling of manganese inclusions and natural flints. This feature was sealed by a clean layer of light grey to brown subsoil **(702)** 0.20m thick.

Above this was a dark layer of topsoil **(701)** 0.12m thick, dark brown to grey in colour and containing small stones and charcoal.

### **Trench 11**

Trench orientation: north north-west to south south-east. Depth: 0.2 – 0.34m. Width: 1.5m.  
Length: 20.8m

One linear **[1101]**

The plan and sections are recorded in Figures 6, 8. The trench lay on a NNW to SSE alignment and measured approximately 20.80m by 1.50m.

Undisturbed natural geology **(1105)** was identified across the trench as grey sticky clay of the Wealden Clay formation, at a depth of approximately 0.39m (20.15mOD) below the present ground surface at 20.54m OD.

Cut into the natural geology mid centre of the trench was a linear approximately 1.93m in breadth, extending from north-east to south-west. The cut **[1101]** had concave sides and a flat base. The fill **(1100)** consisted of a mixture of mid brown grey clay silt with moderate speckling of manganese inclusions and was about 0.53m depth with some pottery sherds and natural flints. Five sherds of pottery of a broadly Prehistoric to Early and Post Medieval date were recovered from the feature.

This feature was sealed by a clean layer of light grey to brown subsoil **(1102)** 0.14m thick.

Above this was a dark layer of topsoil **(1101)** 0.10m thick, dark brown to grey in colour and containing small stones and charcoal, but otherwise relatively clean. This probably represents a post-medieval to modern topsoil layer filled with a high organic content from agricultural or garden use.

## **Trenches 2-45**

### **Trench 2:**

Trench orientation: east to west. Depth: 0.45 – 0.6m. Width: 1.5m. Length: 21.7m. No archaeology was detected. Topsoil (201) was dark brown to grey and 26cm thick overlaying subsoil (202) light grey to brown 12cm thick

### **Trench 5:**

Trench orientation: north to south. Depth: 0.2 – 0.4m. Width: 1.55m. Length: 22m No archaeology was detected. Topsoil (501) was dark brown to grey and 27cm thick overlaying subsoil (502) light grey to brown 13cm thick

### **Trench 6:**

Trench orientation: north to south. Depth: 0.2 – 0.3m. Width: 1.56m. Length: 22.5m No archaeology was detected. Topsoil (601) was dark brown to grey and 25cm thick overlaying subsoil (602) light grey to brown 12cm thick

### **Trench 8:**

Trench orientation: north to south Depth: 0.3 – 0.4m. Width: 1.55m. Length: 21.7m No archaeology was detected. Topsoil (801) was dark brown to grey and 26cm thick overlaying subsoil (802) light grey to brown 12cm thick

### **Trench 9:**

Trench orientation: north-east to south-west. Depth: 0.2 – 0.3m. Width: 1.5m. Length: 28.8m No archaeology was detected. Topsoil (901) was dark brown to grey and 27cm thick overlaying subsoil (902) light grey to brown 12cm thick

### **Trench 10:**

Trench orientation: north to south. Depth: 0.2 – 0.3m. Width: 1.55m. Length: 20.1m No archaeology was detected. Topsoil (1001) was dark brown to grey and 26cm thick overlaying subsoil (1002) light grey to brown 12cm thick

### **Trench 12:**

Trench orientation: east to west. Depth: 0.2 – 0.3m. Width: 1.55m. Length: 17.5m No archaeology was detected. Topsoil (1201) was dark brown to grey and 28cm thick overlaying subsoil (1202) light grey to brown 14cm thick

**Trench 13:**

Trench orientation: north to south. Depth: 0.25 – 0.3m. Width: 1.5m. Length: 19.8m No archaeology was detected. Topsoil (1301) was dark brown to grey and 28cm thick overlaying subsoil (1302) light grey to brown 13cm thick

**Trench 14:**

Trench orientation: north to south. Depth: 0.3 – 0.5m. Width: 1.55m. Length: 15.7m No archaeology was detected. Topsoil (1401) was dark brown to grey and 27cm thick overlaying subsoil (1402) light grey to brown 14cm thick

**Trench 15:**

Trench orientation: east north-east to west south-west. Depth: 0.25m. Width: 1.55m. Length: 29m No archaeology was detected; Trench 15 was blank. Topsoil (1501) was dark brown to grey and 27cm thick overlaying subsoil (1502) light grey to brown 12cm thick

**Trench 16:**

Trench orientation: north to south. Depth: 0.2 – 0.3m. Width: 1.5m. Length: 21.7m No archaeology was detected. Topsoil (1601) was dark brown to grey and 26cm thick overlaying subsoil (1602) light grey to brown 12cm thick

**Trench 17:**

Trench orientation: east to west. Depth: 0.2m. Width: 1.5m. Length: 18.8m No archaeology was detected; Trench 17 was blank. Topsoil (1701) was dark brown to grey and 25cm thick overlaying subsoil (1702) light grey to brown 11cm thick

**Trench 18:**

Trench orientation: east to west. Depth: 0.2 – 0.3m. Width: 1.55m. Length: 16.8m No archaeology was detected. Topsoil (1801) was dark brown to grey and 22cm thick overlaying subsoil (1802) light grey to brown 12cm thick

**Trench 19:**

Trench orientation: east to west. Depth: 0.2 – 0.3m. Width: 1.55m. Length: 16.5m No archaeology was detected. Topsoil (1901) was dark brown to grey and 26cm thick overlaying subsoil (1902) light grey to brown 13cm thick

**Trench 20:**

Trench orientation: east to west. Depth: 0.25 – 0.3m. Width: 1.5m. Length: 18.8m No archaeology was detected. Topsoil (2001) was dark brown to grey and 26cm thick overlaying subsoil (2002) light grey to brown 11cm thick

**Trench 21:**

Trench orientation: north north east to south south west. Depth: 0.3 – 0.5m. Width: 1.55m. Length: 16.7m No archaeology was detected. Topsoil (2101) was dark brown to grey and 26cm thick overlaying subsoil (2102) light grey to brown 12cm thick

**Trench 22:**

Trench orientation: north to south. Depth: 0.25m. Width: 1.55m. Length: 24m No archaeology was detected. Topsoil (2201) was dark brown to grey and 26cm thick overlaying subsoil (2202) light grey to brown 11cm thick

**Trench 23:**

Trench orientation: north to south. Depth: 0.2 – 0.3m. Width: 1.5m. Length: 22.7m No archaeology was detected. Topsoil (2301) was dark brown to grey and 25cm thick overlaying subsoil (2302) light grey to brown 13cm thick

**Trench 24:**

Trench orientation: north to south. Depth: 0.2m. Width: 1.5m. Length: 20.8m No archaeology was detected. Topsoil (2401) was dark brown to grey and 26cm thick overlaying subsoil (2402) light grey to brown 11cm thick

**Trench 25:**

Trench orientation: north to south. Depth: 0.2 – 0.3m. Width: 1.55m. Length: 10.8m No archaeology was detected. Topsoil (2501) was dark brown to grey and 27cm thick overlaying subsoil (2502) light grey to brown 12cm thick

**Trench 26:**

Trench orientation: east to west. Depth: 0.2 – 0.3m. Width: 1.55m. Length: 17.5m No archaeology was detected. Topsoil (2601) was dark brown to grey and 27cm thick overlaying subsoil (2602) light grey to brown 11cm thick

**Trench 27:**

Trench orientation: north to south. Depth: 0.25 – 0.3m. Width: 1.5m. Length: 20.8m No archaeology was detected. Topsoil (2701) was dark brown to grey and 26cm thick overlaying subsoil (2702) light grey to brown 12cm thick

**Trench 28:**

Trench orientation: east to west. Depth: 0.3 – 0.5m. Width: 1.55m. Length: 23.7m No archaeology was detected. Topsoil (2801) was dark brown to grey and 26cm thick overlaying subsoil (2802) light grey to brown 14cm thick

**Trench 29:**

Trench orientation: north to south. Depth: 0.25m. Width: 1.55m. Length: 27m No archaeology was detected. Topsoil (2901) was dark brown to grey and 27cm thick overlaying subsoil (2902) light grey to brown 12cm thick

**Trench 30:**

Trench orientation: east to west. Depth: 0.2 – 0.3m. Width: 1.5m. Length: 17.7m No archaeology was detected. Topsoil (3001) was dark brown to grey and 26cm thick overlaying subsoil (3002) light grey to brown 13cm thick

**Trench 31:**

Trench orientation: north to south. Depth: 0.2m. Width: 1.5m. Length: 22.8m No archaeology was detected. Topsoil (3101) was dark brown to grey and 26cm thick overlaying subsoil (3102) light grey to brown 12cm thick

**Trench 32:**

Trench orientation: east to west. Depth: 0.2 – 0.3m. Width: 1.55m. Length: 24.5m No archaeology was detected. Topsoil (3201) was dark brown to grey and 27cm thick overlaying subsoil (3202) light grey to brown 11cm thick

**Trench 33:**

Trench orientation: north to south. Depth: 0.25 – 0.3m. Width: 1.5m. Length: 16.8m No archaeology was detected. Topsoil (3301) was dark brown to grey and 26cm thick overlaying subsoil (3302) light grey to brown 12cm thick

**Trench 34:**

Trench orientation: east to west. Depth: 0.3 – 0.5m. Width: 1.55m. Length: 24.7m No archaeology was detected. Topsoil (3401) was dark brown to grey and 26cm thick overlaying subsoil (3402) light grey to brown 13cm thick

**Trench 35:**

Trench orientation: north to south. Depth: 0.25m. Width: 1.55m. Length: 23m No archaeology was detected. Topsoil (3501) was dark brown to grey and 26cm thick overlaying subsoil (3502) light grey to brown 12cm thick

**Trench 36:**

Trench orientation: east to west. Depth: 0.2 – 0.3m. Width: 1.5m. Length: 21.7m No archaeology was detected. Topsoil (3601) was dark brown to grey and 26cm thick overlaying subsoil (3602) light grey to brown 11cm thick

**Trench 37:**

Trench orientation: east to west. Depth: 0.2m. Width: 1.5m. Length: 17.8m No archaeology was detected. Topsoil (3701) was dark brown to grey and 27cm thick overlaying subsoil (3702) light grey to brown 12cm thick

**Trench 38:**

Trench orientation: north to south. Depth: 0.2 – 0.3m. Width: 1.55m. Length: 20.8m No archaeology was detected. Topsoil (3801) was dark brown to grey and 26cm thick overlaying subsoil (3802) light grey to brown 11cm thick

**Trench 39:**

Trench orientation north to south. Depth: 0.2 – 0.3m. Width: 1.55m. Length: 25.5m No archaeology was detected. Topsoil (3901) was dark brown to grey and 26cm thick overlaying subsoil (3902) light grey to brown 12cm thick

**Trench 40:**

Trench orientation: east to west. Depth: 0.25 – 0.3m. Width: 1.5m. Length: 25.8m No archaeology was detected. Topsoil (4001) was dark brown to grey and 26cm thick overlaying subsoil (4002) light grey to brown 13cm thick

**Trench 41:**

Trench orientation: north to south. Depth: 0.3 – 0.5m. Width: 1.55m. Length: 18.7m No archaeology was detected. Topsoil (4101) was dark brown to grey and 26cm thick overlaying subsoil (4102) light grey to brown 14cm thick

**Trench 42:**

Trench orientation: north to south. Depth: 0.25m. Width: 1.55m. Length: 21m No archaeology was detected. Topsoil (4201) was dark brown to grey and 27cm thick overlaying subsoil (4202) light grey to brown 12cm thick



### **Trench 43:**

Trench orientation: east to west. Depth: 0.2 – 0.3m. Width: 1.5m. Length: 26.7m No archaeology was detected. Topsoil (4301) was dark brown to grey and 26cm thick overlaying subsoil (4302) light grey to brown 13cm thick

### **Trench 44:**

Trench orientation: east to west. Depth: 0.2m. Width: 1.5m. Length: 15.8m No archaeology was detected. Topsoil (4401) was dark brown to grey and 27cm thick overlaying subsoil (4402) light grey to brown 12cm thick. One modern foundation trench running NW to SE and 1.05m wide was revealed

### **Trench 45:**

Trench orientation: north to south. Depth: 0.2 – 0.3m. Width: 1.55m. Length: 24.8m No archaeology was detected. Topsoil (4501) was dark brown to grey and 26cm thick overlaying subsoil (4502) light grey to brown 14cm thick. One modern foundation trench running NE to SW and 1.05m wide was revealed.

## **10. Discussion**

Given the location between a postulated Roman road and the near vicinity of a Roman settlement, it is perhaps no surprise that archaeology has been encountered. Examples of Prehistoric, Roman and Medieval pottery, albeit mostly residual have been recovered from layers sealed by later deposits. In addition linears (ditches) have been exposed which seem to be field systems.

## **11. Finds**

Five artefacts were recovered by metal detecting and this was in the topsoil in the NE area of the north field. A WW1 mess tin and silver plated cutlery were recovered and a silver coin, a half groat of James 1 dated to 1604-1609. Pottery retrieved from this evaluation has been processed by Nigel MacPherson-Grant whose initial thoughts are: *‘A total of 15 small to moderate sized sherds weighing 50gms were recovered from the evaluation. The overall assemblage is multi-period with Later Prehistoric and Historic periods being recorded. The latter period represents the main general phase of activity on site’*. Subsequently Nigel MacPherson Grant has been in contact with Luke Barber who will be commenting on the fabrics and any subsequent pottery sherds retrieved through excavation.

## **12. Conclusion**

The evaluation trenches at the proposed development site have revealed a number of archaeological features in the way of a pit and linears. Pottery retrieved from some of these features suggested dates ranging from Prehistoric to Medieval with most of the pottery sherds thought to be residual.

The archaeological evaluation has been successful in fulfilling the primary aims and objectives of the Specification. A common stratigraphic sequence was recognised across the site comprised of topsoil **(100)** sealing the subsoil **(101)** which overlay the natural geology of Wealden beds **(102)**. All features were planned in relation to the trenches, and the excavated features were drawn in section at a scale of 1:10. Therefore, this evaluation has been successful in fulfilling the aims and objectives as set out in the planning condition and the Archaeological Specification.

### **13. Acknowledgements**

SWAT Archaeology would like to thank the client, Persimmon Homes (South East) Ltd for commissioning the project. Thanks are also extended to Greg Chuter Archaeological Officer, East Sussex County Council. Illustrations were produced by Jonny Madden for Digitise This. The fieldwork was supervised by Matt Charlwood and Paul Wilkinson, and the project was managed and report written by Dr Paul Wilkinson MifA.

Paul Wilkinson

29/10/2015

### **14. References**

Institute for Field Archaeologists (IfA), Rev (2008). *Standard and Guidance for archaeological field evaluation*

SWAT Archaeology (2015) *Specification for the evaluation of Land (Phase 1) at Rattle Road, Stone Cross, Pevensey, East Sussex*

ESCC HER data 2015

## 16. Appendix 1

### Assessment of pottery from evaluation at land Rattle Road, Stone Cross, Pevensey

A total of 15 small-moderate sized sherds weighing 50gms were recovered during this evaluation. The overall assemblage is multi-period – with between 7-8 Later Prehistoric and Historic periods being recorded. The latter period represents the main general phase of activity on-site.

#### *Later Prehistoric Period*

Two, possibly 3, elements represent the Later Prehistoric phase. *Context 300* produced a single moderate-sized bodysherd from a thick-walled fairly heavily and coarsely flint-tempered coarseware jar of probable Mid to Mid-Late Bronze Age date – **c.1500-1100 BC**. *Context 1400* produced another residual element – a small rather undiagnostic bodysherd from a thin-walled coarseware jar that can only be broadly dated to between approximately **1500-100 BC**. Both these elements are definitely residual in-context – the MBA-type element is fairly heavily worn. However the broader dated sherd from *1400* near-fresh, suggesting that it is derived from immediately adjacent prehistoric activity rather than being re-deposited.

#### *Historic Period*

Seven *Early-Mid Roman* sherds were recorded from 4 contexts – *100* (2), *102* (1), *300* (3) and *400* (1). Most are small bodysherds, 2 (from *300*) are from the same curving everted-rim jar. All are thin-walled, oxidised orange- or pinky-buff and made in the local grog-tempered native coarseware. The degree of oxidisation varies slightly with most elements relatively soft and low-fired. The rim sherd from *300* is marginally harder-fired. The majority are dateable to between **c.100-150 AD** whilst the firing trend and fabric of the rim suggests a slightly later date between **c.175-200 AD**. The sherds from *Context 100* are only slightly worn and *may* derive from an undisturbed contemporary deposit – however the remainder are all highly worn and residual, some in isolation, some in later dated contexts.

A single fairly small only slightly worn bodysherd from a handmade vessel was recorded from *Context 1400*. The fabric is soft, low-fired and has a fine sandy matrix with variably fine linear and larger voids. The linear voids are probably from burnt-out organic inclusions. In addition there are shallow flat-based and angular edged voids, probably from leached-out shell. The poor quality fabric and its ingredient range suggests a Saxon date, with manufacturing trends in keeping – on an inter-regional comparative basis – with the poorer quality potting trends of the *Mid Saxon* period. Tentatively, a date between **c.650-750 AD** is suggested for this element. Its relatively good condition, considering its soft fabric and despite its being residual, suggests derivation from a nearby feature.

A cluster of five sherds represent the post-Roman period. Three are made in East Sussex-type gritty ware – clays containing, or with the addition of, fairly coarse stone beach or river silts. One, from *Context 1400*, is small and heavily worn, its darkish pinky-grey firing colours indicating a late *Early Medieval* date, arguably between **c.1150-1225 AD**. The remaining two, one each from *Contexts 300* and *400*, are more fully oxidised an orange buff. These are from fairly thin-walled vessels of later thirteenth-earlier fourteenth century *Medieval* date. Those from *300* and *1400* are worn and residual in-context – that from *400* although the latest element recorded is also probably residual.

A single moderate-sized bodysherd from *Context 1400* is of *Post-Medieval* date. It is made in a fine sandy-silty earthenware, fired buff-pale range and has a drab thin brown slightly iron-flecked internal glaze. It is from a bowl, deep dish or pipkin made between approximately **1575-1650 AD** or slightly later. It is moderately worn and residual in-context.

Finally, a single small fresh unworn scrap from *Context 1400* is from a *Late Post-Medieval* pantry or kitchenware vessel made in a hard-fired red-earthenware with, overall, a good shiny brown iron mottled glaze. A date between **c.1750-1850 AD** is likely to be appropriate for this element.

Summarising – the broadly dated Late Prehistoric element from *Context 1400*, possibly the Early Roman sherds from *Context 100* and almost certainly the probable Mid Saxon sherd from *1400*, are likely to be derived from contemporary features on-site or very nearby. All the remainder, with the slight exception perhaps of the moderate-sized MBA element, are small and mostly heavily worn and the sort of material that is typically derived from agricultural manure spreads.

#### **Simplified period-based context content**

**100** = ER – *probably residual*

**102** = ER – **residual**

**300** = MBA-type, ER, ER>MR, EM – **residual**

**400** = ER (residual), M

**1400** = LP, EMS-MLS (?), EM, PM, LPM – **all residual except LPM**

Analyst : N.Macpherson-Grant 9.2015

PLATES



Plate 1 – Trench 1. Feature [101] 10cm segment scales

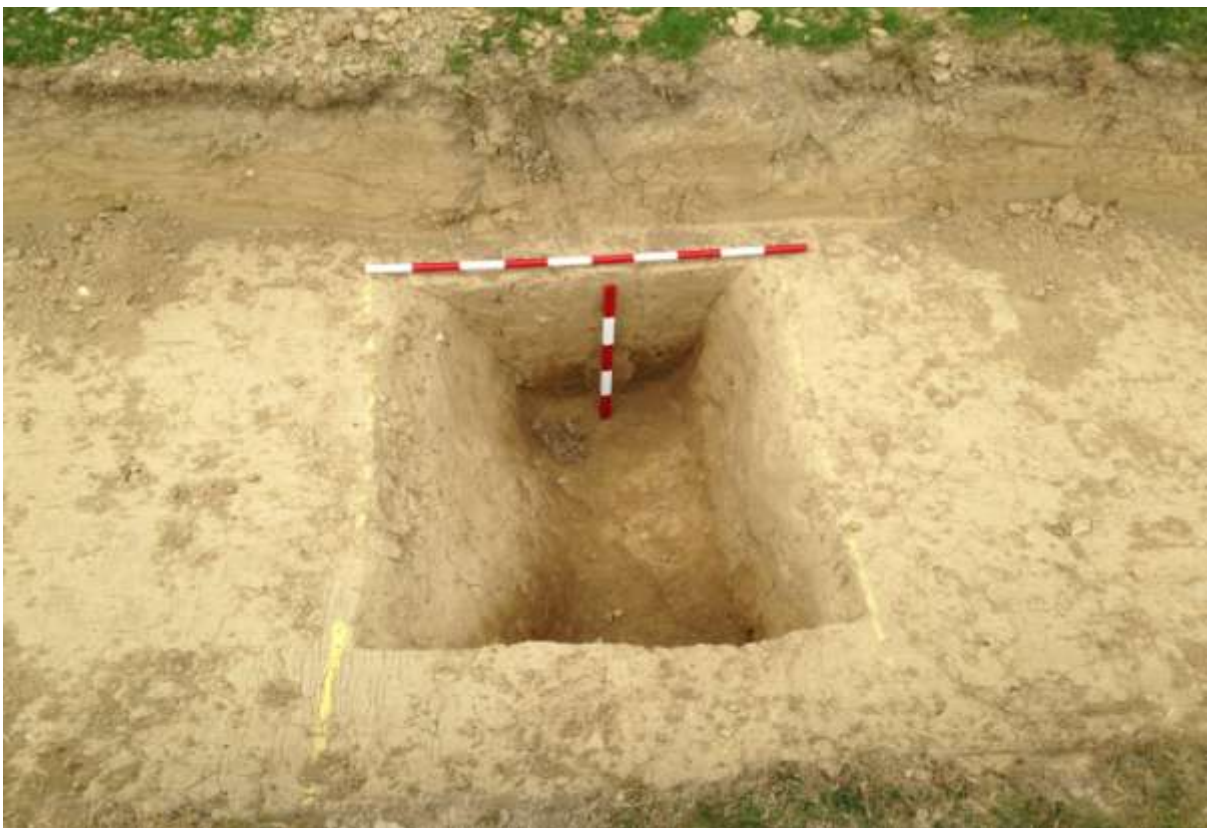

Plate 2 – Trench 3. Feature [301] 10cm segment scales



Plate 3 – Trench 4. Feature [401], 10cm segment scales.



Plate 4 – Trench 7. Feature [701], 50cm scale.



Plate 5 – Trench 11 looking north, 10cm segment scales



Plate 6. Metal detected small finds



562100.0mE  
104855.0mN

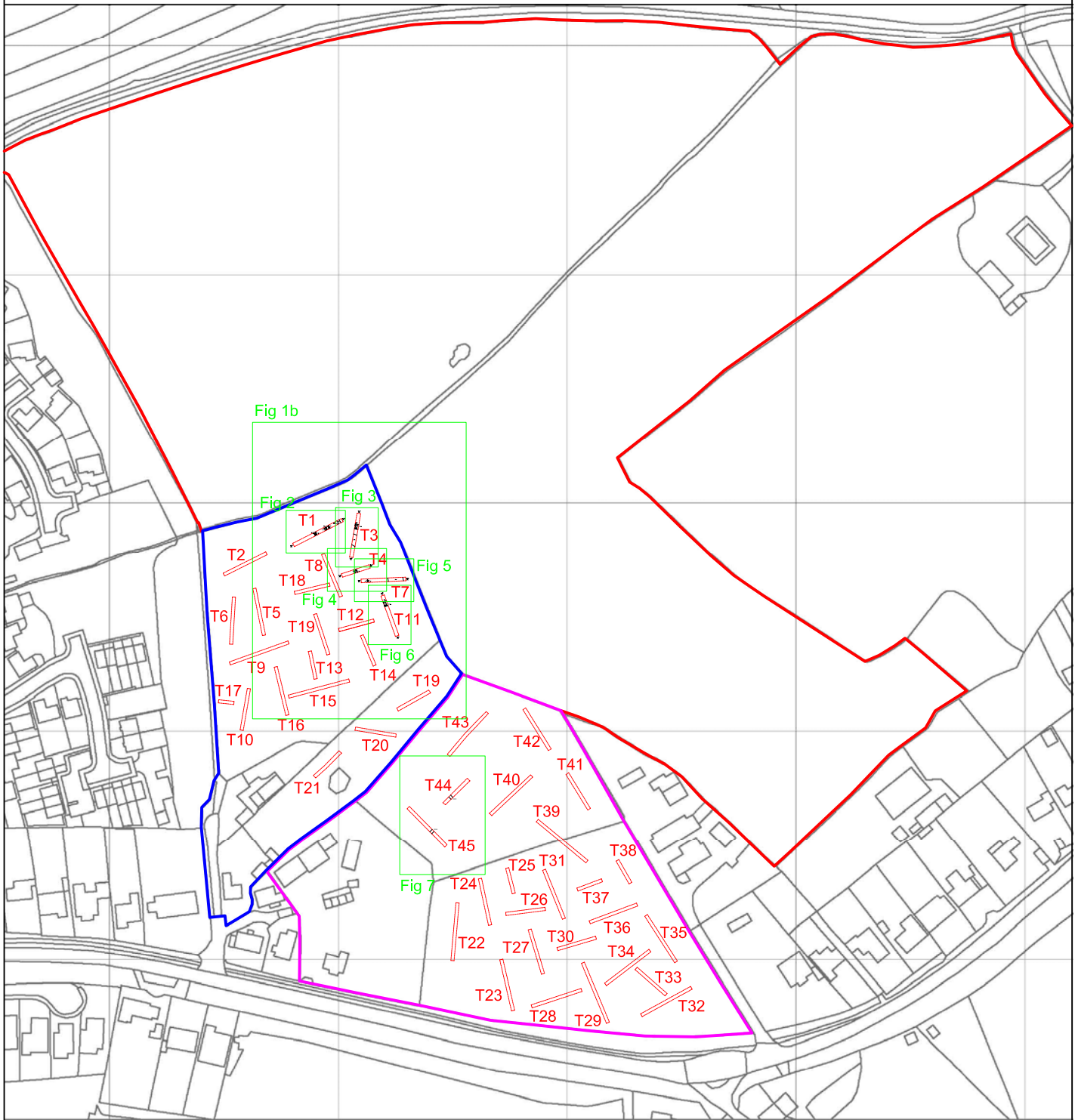
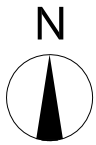

562450.0mE  
104305.0mN

1:2500@A4

Figure 1: Location of archaeological evaluation trenches



1:500@A4

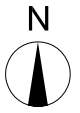

0m

50m

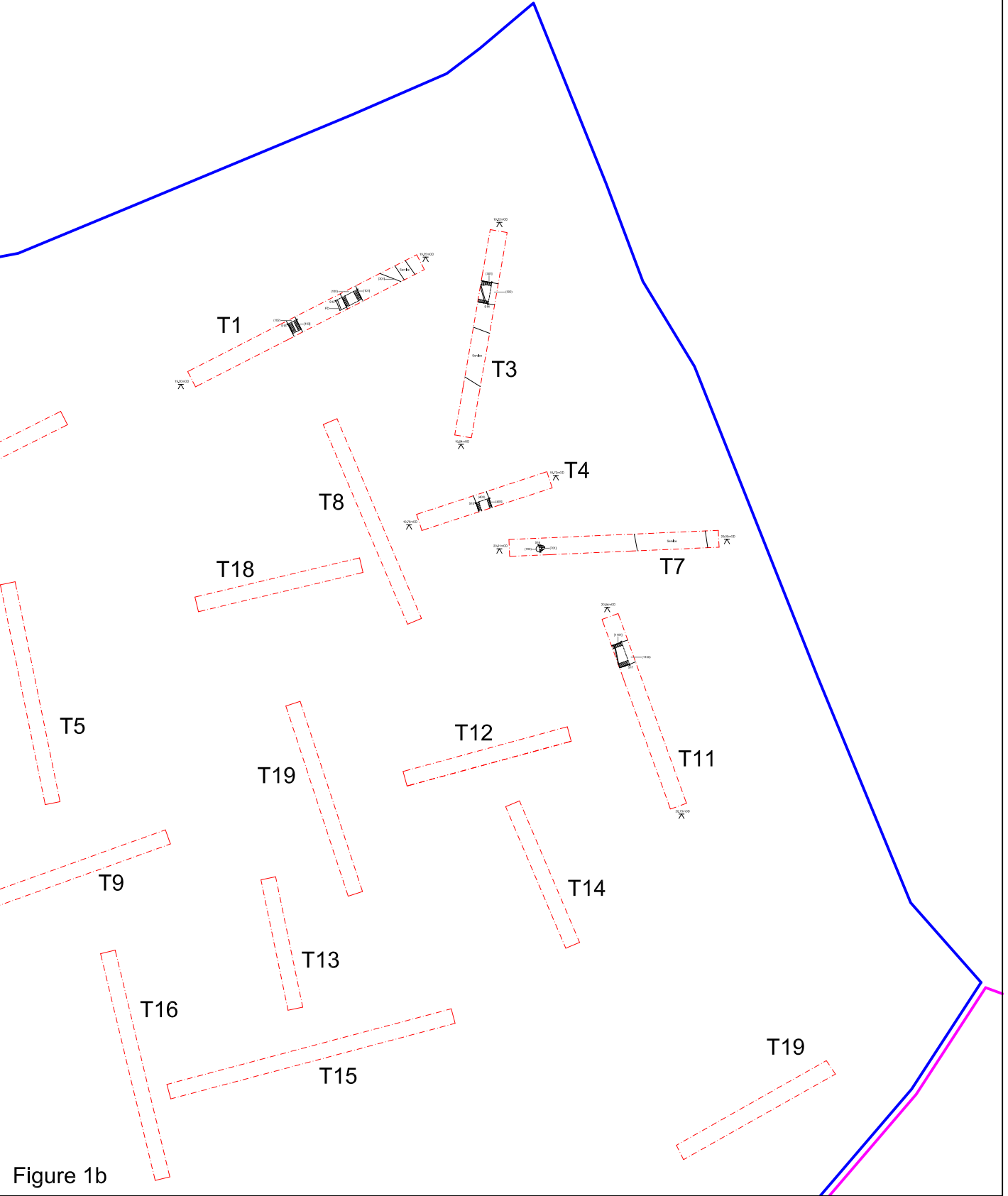
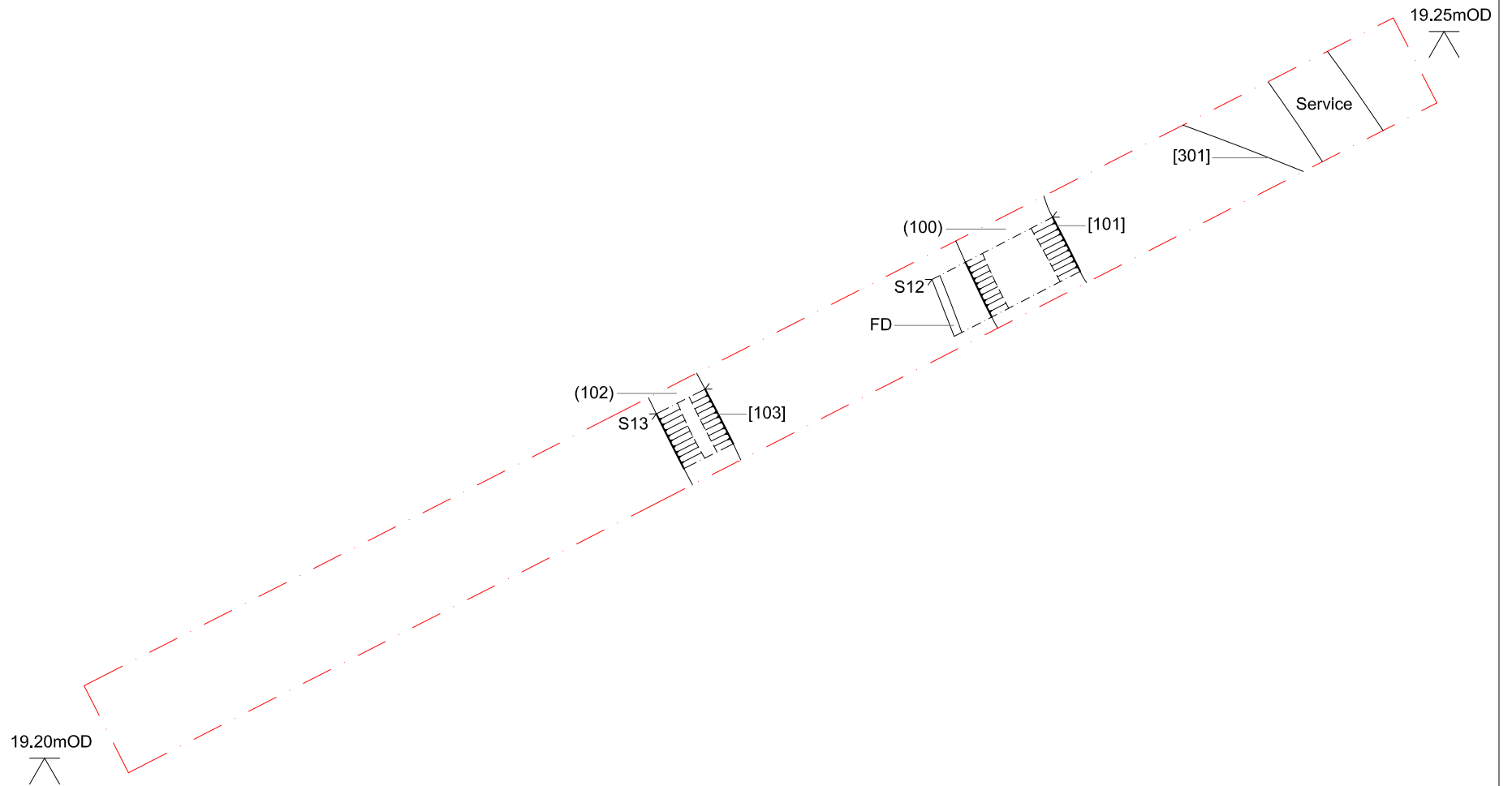
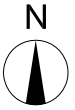

Figure 1b



1:100@A4

0m

10m

Figure 2: Trench 1

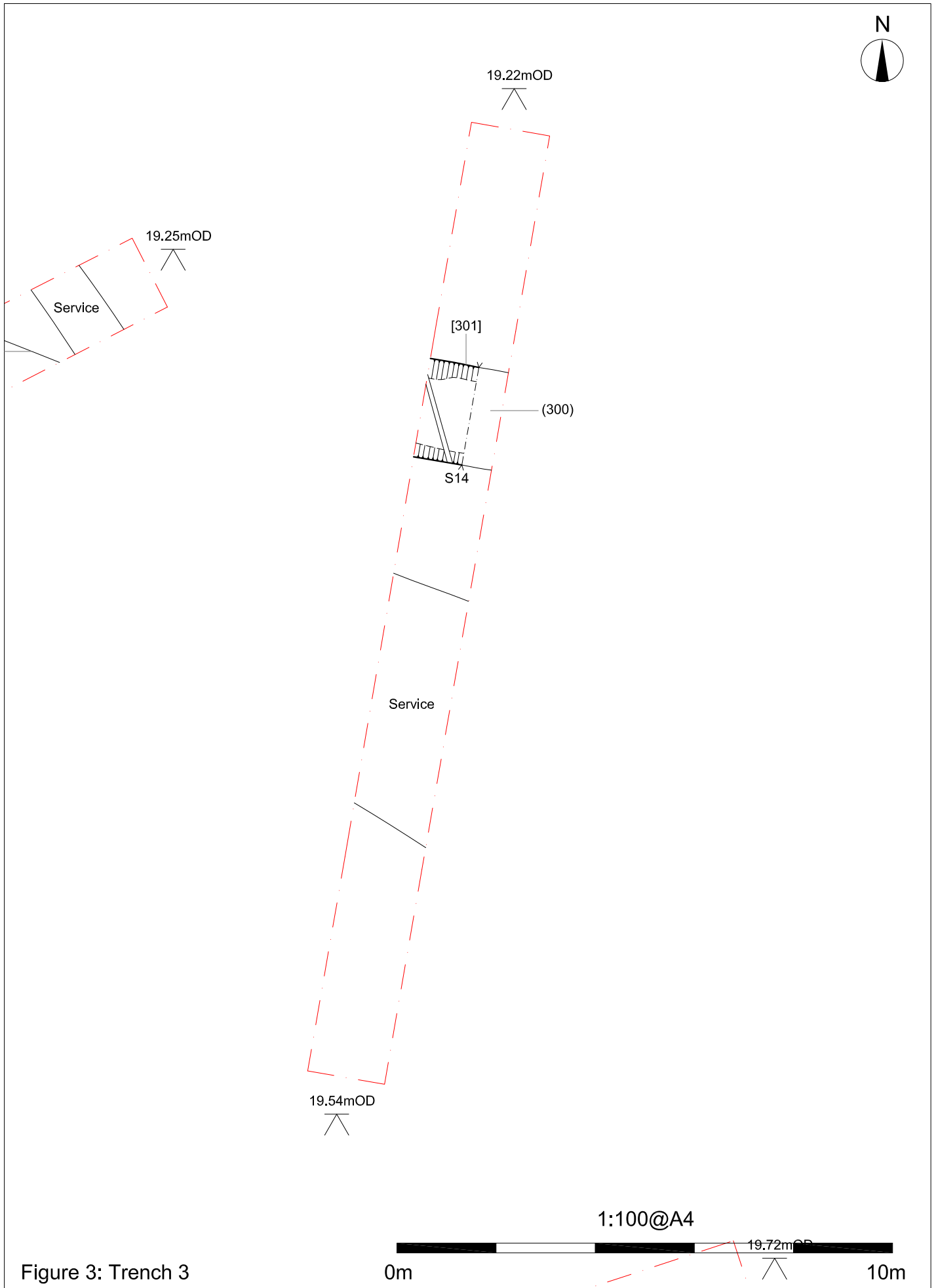
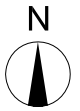

Figure 3: Trench 3

0m

1:100@A4

19.72mOD

10m

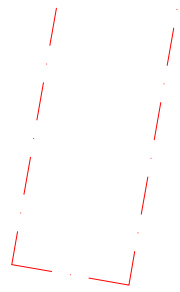
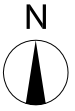

19.54mOD  
^

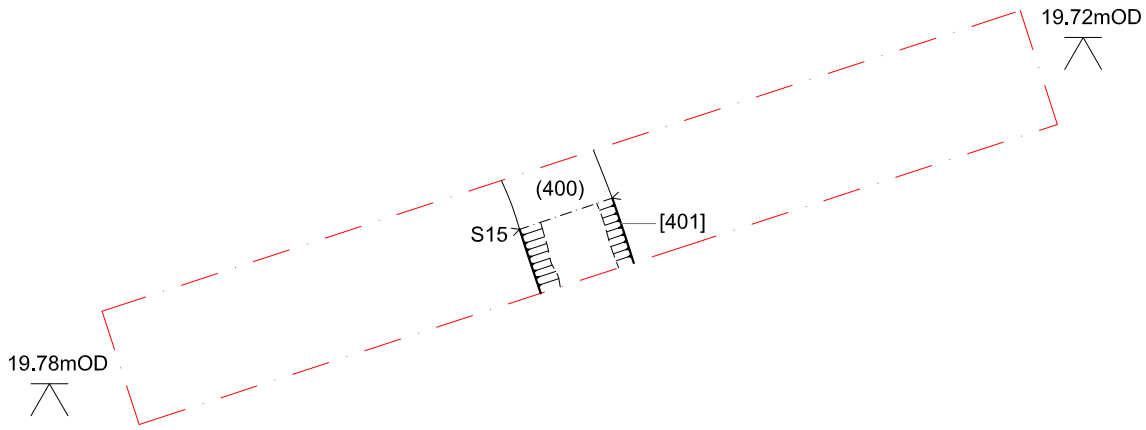

19.78mOD  
^

19.72mOD  
^

20.01mOD  
^

S16  
(700) [701]

1:100@A4



Figure 4: Trench 4

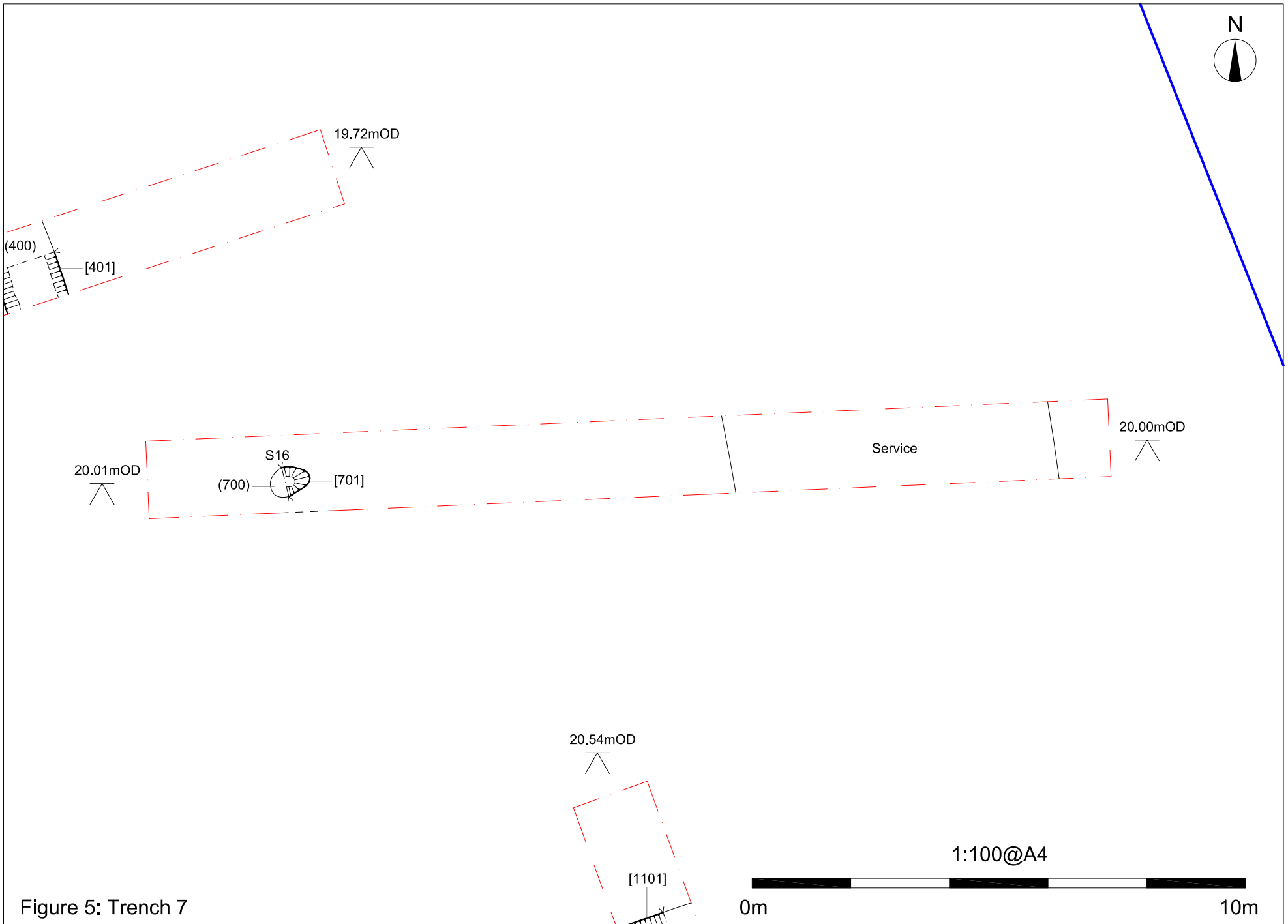
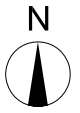

Figure 5: Trench 7



20.54mOD



[1101]

(1100)

S17

20.73mOD



1:100@A4

0m

10m

Figure 6: Trench 11



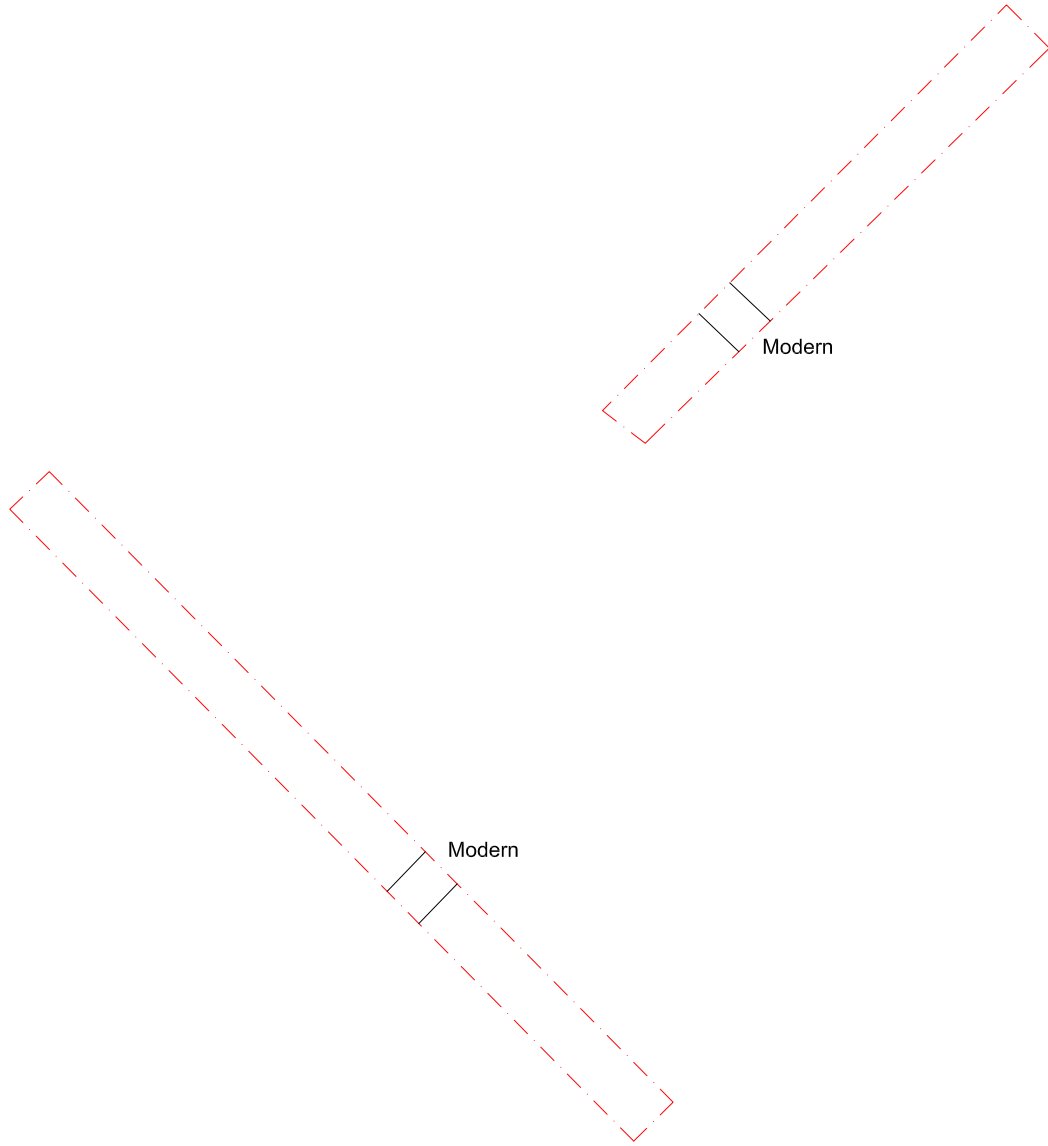
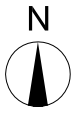

1:200@A4

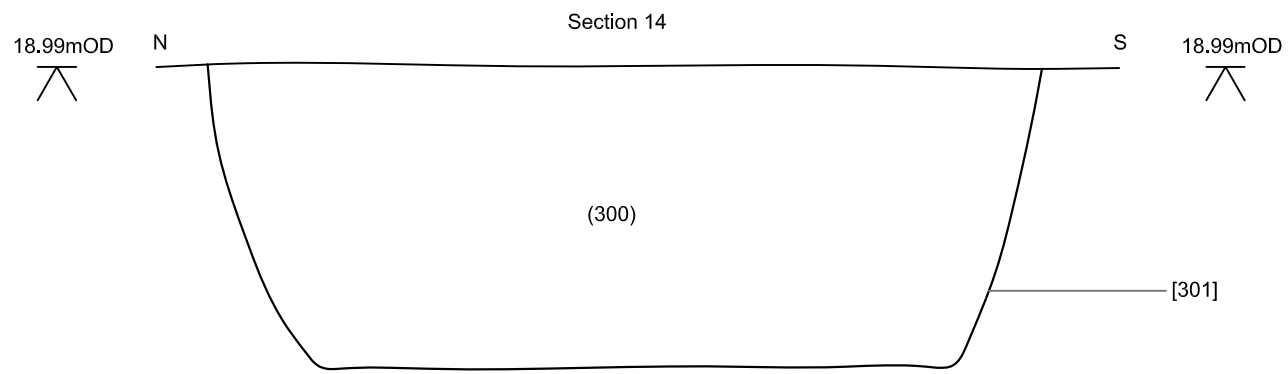
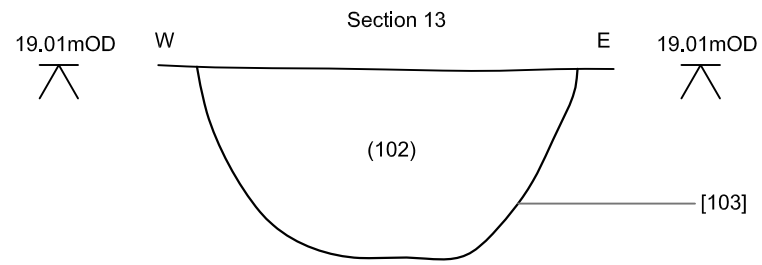
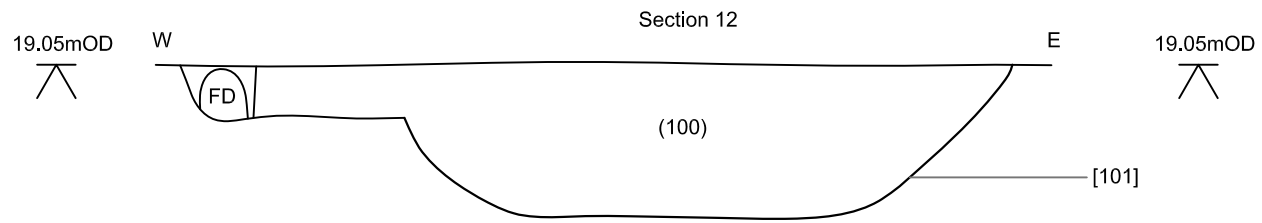

Figure 7: Trenches 44 and 45

0m

20m





1:20@A4



Figure 8: Trenches

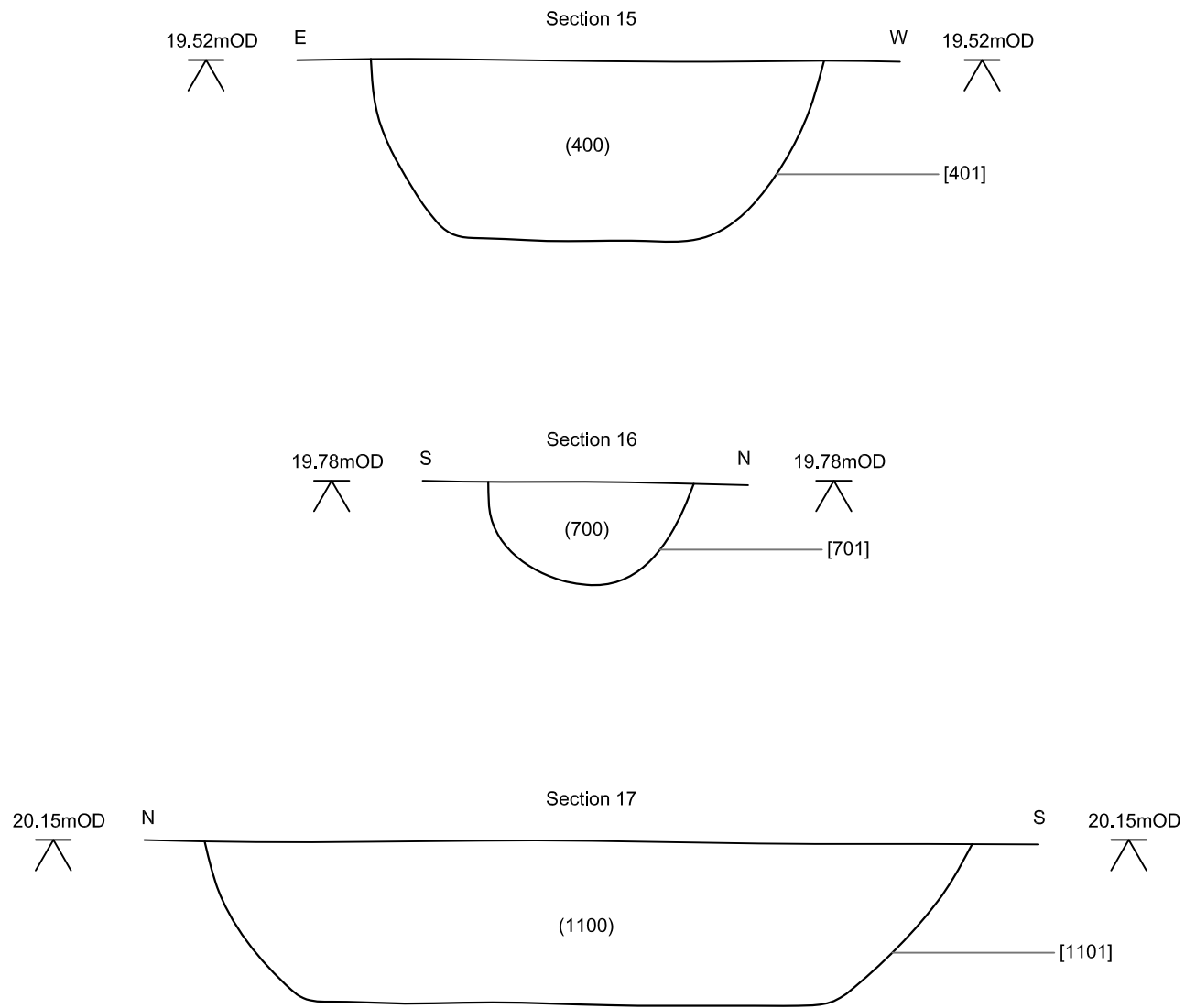

1:20@A4



Figure 9: Trenches